

Back to Basics: An Antenna Primer for New QRP Operators

L. B. Cebik, W4RNL
1434 High Mesa Drive
Knoxville, TN 37938-4443
e-mail: cebik@cebik.com

Every dozen years or so, we may find it useful to start over again. The last 11 FDIM proceedings have contained my tentative contributions, each of which has tried to advance the study of antennas into more advanced territory. As the material covered more sophisticated antennas, my e-mail continued to bring essentially the same fundamental questions. Some have involved horizontal antennas; others have involved vertical antennas. A final collection focused on bent antennas, such as the inverted-V and the inverted-L. Whether used in the field or at home, all of the antennas share some common traits. They are basic antennas, not complex arrays of elements. They show signs of modern urban and suburban living conditions, such as small yards and the absence of tall supports. In short, virtually all of the antennas in question are typical of both the beginning amateur and the experienced retired amateur moving to a simpler system.

Therefore, these notes will look at three basic type of HF antenna: the horizontal wire, the vertical elements, and the bent antenna. I have two goals. One is to develop a reasonable set of expectations about the performance of these basic aerials. If your reasonable expectations do not match your operating desires, then it is time to re-think your antenna situation. The second goal to is sort out the correct ways to handle each kind of antenna within the overall antenna system. The handling guidance will be general rather than dictatorial. However, by the time we are finished, we shall have mastered the art of talking about these basic antennas in ways that do not mislead our own thinking about them.

The antenna itself, that is, the radiating portion of the system, is only one component of the total system. The feedline, whether coaxial cable or parallel transmission line, is equally important and deserves the same care and attention as the radiator. Indoors, we may have an antenna tuner, although for many antenna systems, remotely tuned weatherproof tuners often live out of doors. An antenna system may also have a number of auxiliary components, such as ground rods and straps, switches—sometimes remotely operated, sometimes as simple as a knife switch—and lightning protection components. The HF antenna system for a home station, even if simple in concept, often contains more separated components than the station in the shack. Examine **Fig. 1** for a partial count of typical components.

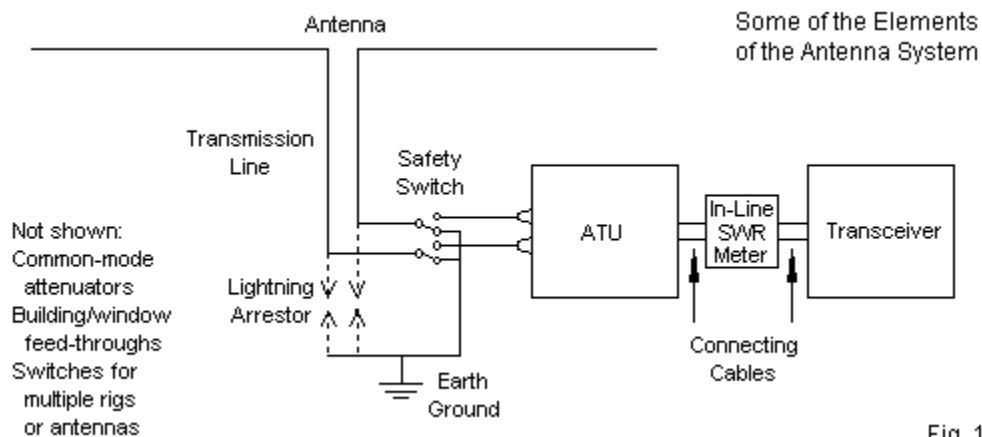

Fig. 1

The figure shows a center-fed horizontal antenna and gives the impression of a parallel feedline. We may substitute a vertical antenna, and some antennas of either type may use coaxial cable as the

feedline. Some antennas may not need an antenna tuner, if they present an approximate 50-Ω impedance at their terminals and therefore also at the shack-end of a 50-Ω transmission line. In some cases, the SWR meter may be built into the transceiver. So we can sometimes—but not always—reduce the number of components. Where we often see the largest number of omissions is with respect to the safety equipment. I shall not ask how many home installations have lightning arrestors or safety switched (or patch-cable set-ups) to ground the antenna outdoors when a storm approaches. Even if the latter system exists, I would be impolite to ask the last time it was used. If you do not have such safety features, please obtain and install them. If you do have them, especially the safety switch, please use them. While switching the antenna to a good safety ground rod, also remember to do a complete disconnect of your equipment from all connections to the outside world, including the AC lines and the equipment ground buss. Sensitive solid-state devices do not care whether a surge enters along the signal path or the circuit common: the momentary excess voltage spike across the device is usually enough to fry it.

To differentiate our discussion from the standard handbook matter, we shall approach the three types of antennas from a different angle. A basic antenna cannot radiate more energy than we supply, whether we count the energy in milliwatts, watts, or kilowatts. Since we shall not work with multi-element arrays, we cannot obtain more directional gain than the basic wire or element permits as a function of its orientation. What differentiates a successful antenna from an unsatisfactory antenna in this context is a matter of knowing where our signals are going and matching those directions to our desires. So in a very real sense, the basic ideas will be all about angles.

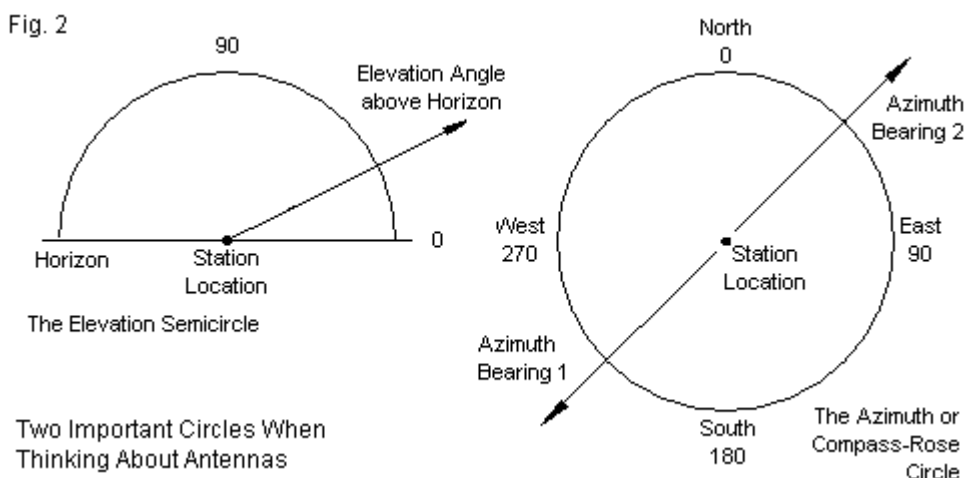

Fig. 2 shows two circles, each with its own set of angles that will be important to us. On the left is the semicircle of elevation above the horizon. For simplicity, the circle markings count from the horizon (0°) up to the zenith (90°). You may sometimes see the other horizon listed as 180° or as 0°. We shall use the latter simpler system and call all elevations at the horizon 0°. We count the elevation angle at right angles to the plane of the ground (using a simplified flat-earth system) as 90°. The circle on the right counts degrees in a plane that is parallel to the ground. Since a complete circle has no inherent starting point, we give it one, in this case, due north. If we call this direction 0° and count clockwise around the circle, we obtain a very conventional azimuth scheme that coincides with the system used in mapping. The method of counting azimuth angles is convenient for everyone except those who may find themselves at either the North or the South Pole. The sketch shows two azimuth bearings, suggesting that in many instances, we may be concerned with more than one azimuth angle.

Between the elevation semicircle and the azimuth full circle, we may fully specify the direction of our signals anywhere around the world relative to our station location. Note that I have shown the station location as a dot, just big enough to be visible. Unlike AM broadcast stations and FM repeater conversations, we are not concerned in the HF region of the spectrum with straight-line or ground wave communications. (Of course, there are exceptions, but we shall work with what is generally true of

amateur operations.) We most often refract our signals through the ionospheric portions of the upper atmosphere to communicate with other stations via skip—using one or more hops along a given path. Hence, the elevation and the azimuth angles of our signals hold equal importance to successfully completing a contact. We shall assume that the ionosphere is working well. If it is not working well, all we can do is to wait for it to repair itself. Nothing that we can do to a basic antenna system will help a dead band.

To this basic orientation for our work, we shall add necessary antenna terminology and facts as we move along. However, much of that information will be specific to each of the three generic types of antennas with which we deal along the way.

Horizontal Antennas

Basic horizontal antennas include center, off-center, and end fed wires, not to mention loops that have varying circumferences between about 2λ and 4λ . The linear wires can have any length. We might have a dipole (any center-fed wire no longer than $\frac{1}{2}\lambda$), a resonant dipole (a center-fed wire that is exactly $\frac{1}{2}\lambda$) or a much longer wire (a center-fed doublet). Equally, we might have an OCF (off-center-fed wire) or a Zepp (an end-fed wire). What all of these antenna types share is the fact that the elevation angle of their main radiation lobes changes with the height of the antenna above ground, when measured in wavelengths. **Fig. 3** portrays this very basic importance of horizontal antenna height.

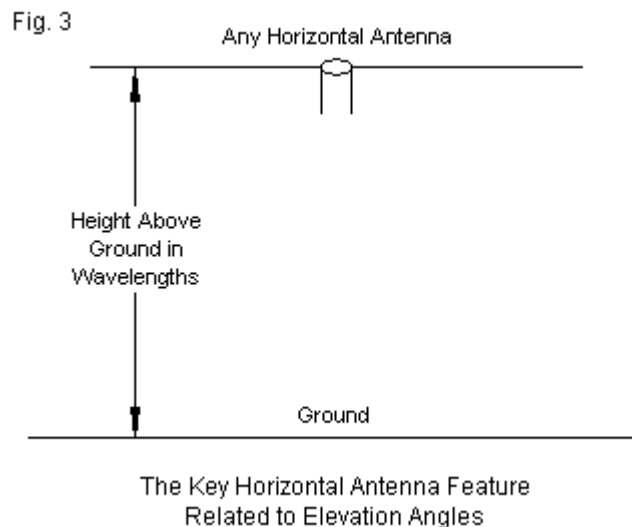

The first problem that most amateurs encounter is their habit of thinking in terms of physical distances. Terrain, construction, and legal restrictions all use physical dimensions, and so we typically fail to convert these numbers into wavelengths for our antenna expectations. However, in making the conversions, we can generally ignore differences in ground quality, since their impact on the elevation angle of our signals is so small. The actual elevation angle for our skip signals is a function of the interaction between the direct or incident radiation and the component that reflects from the ground at a distance from the antenna—far enough that we do not have any control over its quality. Therefore, in developing reasonable expectations from our antennas, we need only know how to convert a height (let's use feet as our physical measure) into a wavelength or a fraction thereof—and then what that height means for the elevation angle.

To make the conversion, we may use a pair of traditional approximate equations:

$$h(\lambda) = h(\text{ft}) / \lambda(\text{ft}) \quad \text{and} \quad \lambda(\text{ft}) = 984 / f(\text{MHz})$$

The letter h is the height, while λ is a wavelength and f is the frequency of concern. In almost all cases, we need not be fussy with the frequency and can use any convenient value within an amateur band. The only exception is the traditional distinction between the ends of the band that covers 80 and 75 meters.

Since the math usually needs a calculator, you may use **Table 1** instead. It uses the center frequency of each band, along with 3.6 and 3.9 MHz in the large lower HF amateur band.

Table 1. Some physical heights corresponding to horizontal antenna heights in λ

Band	Freq.	$h = 1 \lambda$	$h = 0.5 \lambda$	$h = 0.25 \lambda$	$h = 0.125 \lambda$
Meters	MHz	feet	feet	feet	feet
160	1.85	532	266	133	67
80	3.6	273	137	68	34
75	3.9	252	126	63	32
60	5.36	184	92	46	23
40	7.15	138	69	35	17
30	10.125	97	49	24	12
20	14.175	69	34.5	17	9
17	18.12	54	27	14	7
15	21.225	46	23	12	6
12	24.95	39	20	10	5
10	28.5	35	17	9	5
Elevation Angle					
Degrees		14	27	62	90

Note: elevation angles are approximate.

There are some old equations for calculating the angle of the lobes of a horizontal antenna above perfect ground, but the table uses values for average ground. The intermediate heights show a bit of variability (+/-3 to 4 degrees) but the 1- λ and the 0.125- λ heights are virtually invariable.

To answer the question what these elevation angles mean to our signals, let's look at a gallery of elevation plots, shown in **Fig. 4**. Frequency means very little in this regard, since the heights are in wavelengths.

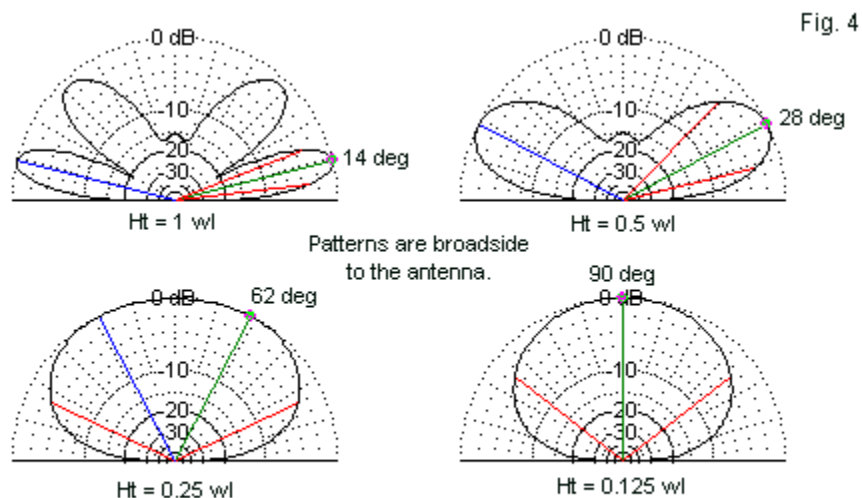

The Elevation Angle of Radiation of A Horizontal Antenna Increases as Its Height (in Wavelengths) Decreases

When we approach a height of 1 λ , the pattern develops multiple elevation lobes, about as many lobes as the height is in wavelengths. The lowest lobe holds the highest interest, since most long-distance communications skip angles are low. As we reduce the antenna height to 0.5 λ , the elevation angle for most of the energy rises. Even though the angle of maximum radiation is fairly high, there is enough energy at lower angles for successful communications. The strength of the signal does not

diminish much at this reduced height. However, by the time we reduce the height to about 0.25λ , the angle has grown very high, and the strongest lobe has lost about 1.25 dB in maximum strength—mostly due to energy loss to the closer ground. The pattern is still useful for moderate distances, and there is enough energy at low angles for an occasional long-distance contact. At the lowest height ($1/8 \lambda$), the pattern has much less energy below 45° elevation, making long-distance communications rare. In fact, the antenna is even lower than would be optimal for near-vertical incidence skywave (NVIS) communications. For that mode of communications, horizontal antenna heights between 0.15λ and 0.2λ are best.

The patterns apply with only minor variations to virtually all soil types and to all HF bands. However, the physical heights associated with the patterns change radically as we change the operating frequency. If our antenna is at about 35' above ground, we do not obtain a pattern even as mediocre as the $0.25\text{-}\lambda$ plot until we move up to 40 meters. At that height, an 80-meter horizontal wire is only about $1/8 \lambda$ above ground. Common backyard heights for amateur antennas on the lowest bands do not hold much promise of long-distance communications until they reach much greater heights than we can usually manage. At the same time, the 35' typical amateur wire antenna is quite satisfactory for the upper HF range from 20 meters onward.

We noted that the elevation angle of radiation is related most strongly to the antenna height, especially for linear wires. It is not directly related to the method of feeding or to the feedpoint position along the wire. **Fig. 5** overlays the broadside elevation patterns of 3 wires, all $1/2 \lambda$ long and $1/2 \lambda$ above ground. The only difference is the feedpoint position. One wire uses center feeding. Another uses off-center feeding about 30% of the distance between ends. The third uses an end feedpoint. All three patterns overlay perfectly so that only one line shows.

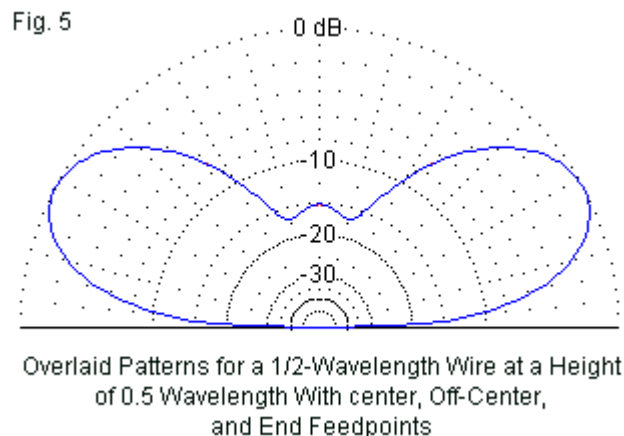

There are exceptions to our general situation. Horizontal loops close to 1λ in circumference radiate broadside to the loop, and very large loops relative to the frequency of operation may show erratic patterns of radiation. Exceptionally long linear wires—the component antennas of true V-beams and rhombics—may show slightly lower elevation angles. Nevertheless, if you wish to have lower elevation angles in the lower HF range with a horizontal antenna, there is no substitute for height. If you cannot obtain acceptable height for your operating desires, you may have to think about other types of antennas.

So far, we have focused on elevation angles. Let's also review what happens to the azimuth patterns with horizontal wires. Here we need to think about two dimensions. One is the antenna height. We may begin with a resonant $1/2\text{-}\lambda$ dipole. We think of the classic textbook picture of a figure-8 pattern because the antenna is bi-directional, with equal strength in each broadside direction relative to the wire. However, when we actually build such a dipole over real ground, the figure-8 begins to go to pot, almost literally in dietary terms, as we bring the wire closer to the ground, measuring the height in wavelengths. **Fig. 6** overlays azimuth patterns for horizontal dipoles at heights of 0.25 , 0.5 , and 1.0λ . Consult **Table 1** for the corresponding physical heights on each amateur band.

Overlaid Azimuth Patterns for
a 1/2-Wavelength Wire
at the Indicated
Heights

Fig. 6

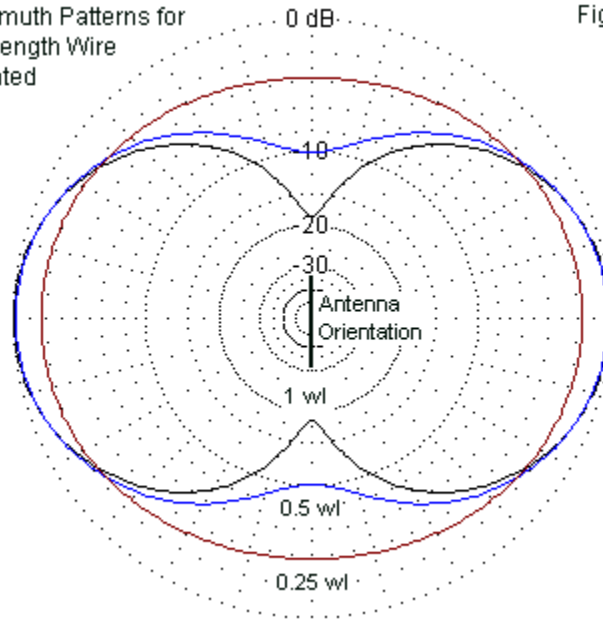

Even at 1λ , the figure-8 has become a peanut, with a broadening waist (off the wire ends) as we lower the height. At a quarter-wavelength, the pattern is a broad oval. If you wish to obtain a bi-directional pattern, you must have enough height.

The patterns in **Fig. 6** apply only to horizontal wires that are about $\frac{1}{2}\lambda$ long at the operating frequency. The azimuth pattern for a linear wire antenna change as we increase the length. We can change the length in two ways, if we remember that we are measuring in terms of wavelengths. First, we can physically shorten or lengthen the wire using the same operating frequency. Second, we can change the operating frequency and keep the physical wire length. A half-wavelength wire at 40 meters is a full-wavelength wire on 20 meters. Regardless of which way we work, the results on our patterns are the same.

Some folks use monoband dipoles, each with a coaxial feedline as a convenient method of feeding. However, one of the most popular backyard antennas is the multi-band center-fed doublet. (A dipole becomes a doublet when the length is greater than $\frac{1}{2}\lambda$.) The most efficient method of feeding the center-fed doublet is with parallel transmission line to a balanced antenna tuner. This system transforms the complex impedance at the antenna terminals down the line to another complex impedance at the tuner terminals, since an unmatched transmission line is an impedance transformer. The tuner transforms the impedance at its terminals to a desired value, usually 50Ω . Since the antenna and the tuner terminal impedance will change as we change bands, we normally do not use 4:1 baluns, since many designs can be quite lossy if the impedance on the load side is very reactive—a perfectly normal situation for a multi-band doublet.

As we change frequency or change the physical length of our wire, the azimuth pattern undergoes changes. Beyond a certain length—about 1.25λ —the main pattern lobes are no longer broadside to the wire. In addition, the number of lobes tends to increase as the wire grows longer in wavelengths at an operating frequency. However, the number of lobes grows in a seemingly complex way. Lobes do not simply appear and disappear. Instead, they grow and diminish as we gradually lengthen a wire (or raise the operating frequency). Lobes for a 1λ wire diminish as we increase the length, and the lobes for a 2λ wire begin to appear long before we reach that length. Hence, intermediate lengths show both sets of lobes. In the process, we find another exasperating phenomenon: the direction of the strongest lobes undergoes a nearly continuous change. Ideally, an animated video would be ideal to show this set of

changes, but we shall have to be content with the gallery of azimuth patterns in **Fig. 7**. The wire is at a constant 1λ above average ground.

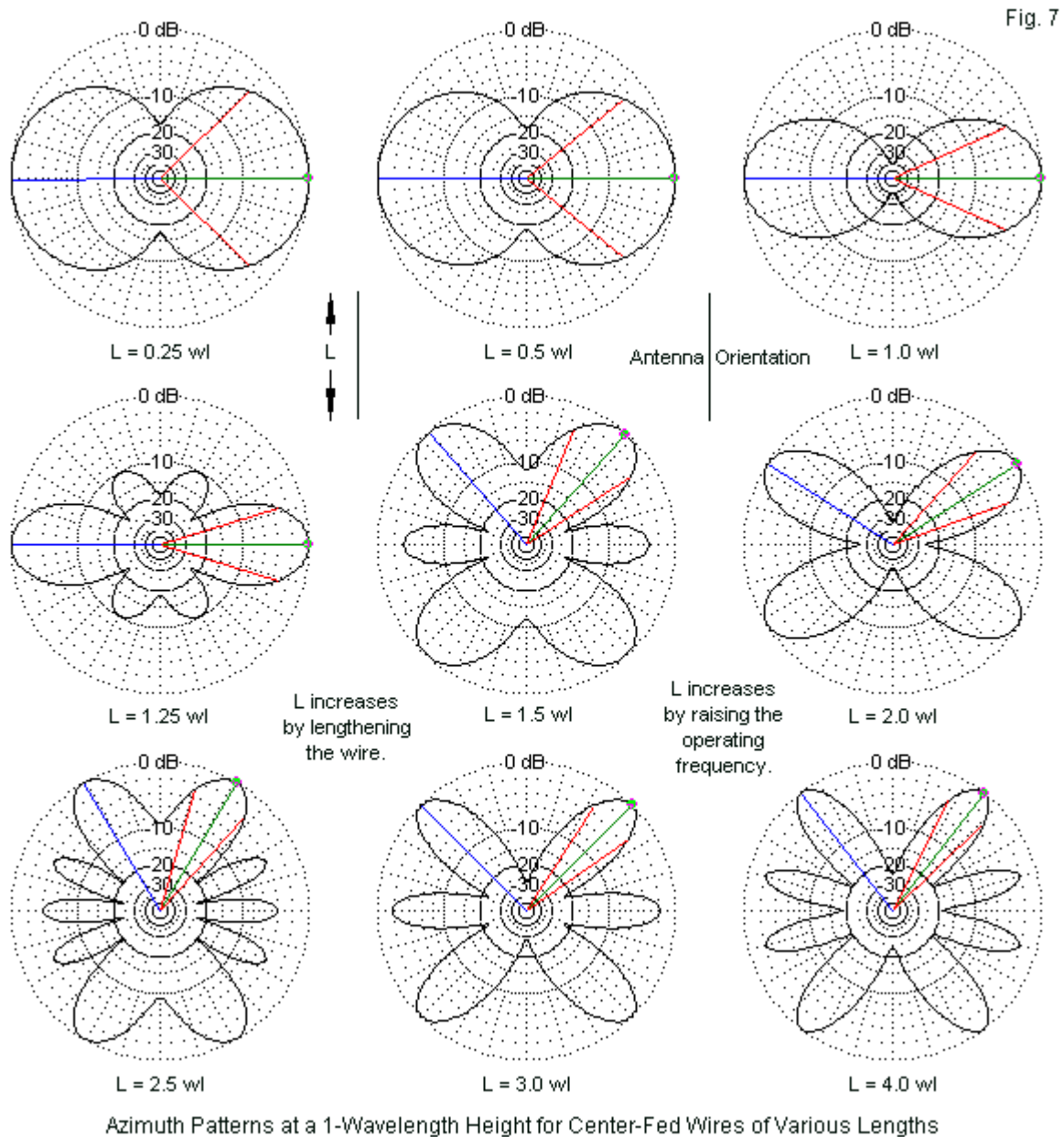

The patterns do not show relative gain. As we move from a $0.25\text{-}\lambda$ wire to a $1\text{-}\lambda$ wire, we notice that the beamwidth narrows, and the gain increases slowly in the process. $1.25\text{-}\lambda$ is the longest wire length for which we can obtain a true bi-directional pattern, but notice that the lobes for a $2\text{-}\lambda$ length have begun to emerge. At $1.5\text{-}\lambda$, the new lobes have begun to dominate, but the broadside $1\text{-}\lambda$ lobes are still there, for a total of 6 lobes. When we reach a full $2\text{-}\lambda$, the broadside lobes have disappeared, leaving only 4 lobes. Let's also note another feature: the more lobes we have in the pattern, the more that the strongest lobes move toward the ends of the wire—but they never reach it. Hence, the strongest lobes as we increase the wire length from $1\text{-}\lambda$ to $2\text{-}\lambda$ (or move the operating frequency to double its initial value) shift from broadside to a high angular value and then back to a more modest one. We see the same action as we move from a $2\text{-}\lambda$ wire through the $2.5\text{-}\lambda$ wire to a final $3\text{-}\lambda$ wire. The $4\text{-}\lambda$ wire has the same relationship to the $3\text{-}\lambda$ wire, and you can interpolate the intermediate stages.

One final note about the patterns in the gallery: as we increase the wire length (or the operating frequency) and the number of lobes increases, the width of each lobe decreases. We may not notice the effect at lower frequencies, but on 10-meters (where a 135' wire is about 4λ long) the antenna is both higher and longer in wavelength terms. Hence, the patterns are sharper. A very sloppy sagging center-fed doublet that waves in the wind may show some signal strength ups and downs. Hence, use great care when installing even a simple center-fed doublet multi-band antenna.

As a handy reference, **Table 2** catalogs some commonly used center-fed doublet lengths and lists the electrical length of the wire at the approximate center of each amateur band (with dual entries for the 80-75-meter band). Do not be overly fussy about the length, since the patterns change slowly, and a single decimal place would do for correlating the lengths to the nearest pattern in the **Fig. 7** gallery. In addition, the wire lengths are useful over a $\pm 5'$ change. For example, the 100' entry also covers the 102' length of a typical G5RV set-up. The italicized entries indicate rather distinct multi-lobe patterns.

Table 2. Lengths in physical units and wavelengths for some popular doublet sizes at various frequencies

Frequency in MHz	Physical Length in feet					
	44'	67'	88'	100'	125'	135'
	Electrical Length in λ					
1.85	0.08	0.13	0.16	0.19	0.24	0.25
3.6	0.16	0.25	0.32	0.37	0.46	0.49
3.9	0.17	0.27	0.34	0.40	0.50	0.54
5.36	0.24	0.37	0.48	0.54	0.68	0.74
7.15	0.32	0.49	0.64	0.73	0.91	0.98
10.125	0.45	0.69	0.90	1.03	1.29	1.39
14.175	0.63	0.97	1.26	<i>1.44</i>	<i>1.80</i>	<i>1.95</i>
18.12	0.81	1.23	<i>1.62</i>	<i>1.84</i>	<i>2.30</i>	<i>2.49</i>
21.225	0.95	<i>1.45</i>	<i>1.90</i>	<i>2.16</i>	<i>2.70</i>	<i>2.91</i>
24.95	1.12	<i>1.70</i>	<i>2.23</i>	<i>2.54</i>	<i>3.17</i>	<i>3.42</i>
28.5	1.28	<i>1.94</i>	<i>2.55</i>	<i>2.90</i>	<i>3.62</i>	<i>3.91</i>

- Notes: 1. Boldface entries are not recommended for use.
 2. Italicized entries indicate non-broadside main pattern lobes.

The importance of the chart becomes evident when you install the doublet. Suppose that you can set the wire at any azimuth angle. Also suppose that you wish to work Europe from the US. You cannot ask yourself what the best antenna orientation is until you also decide on which band you wish to work European stations. If you choose a band with multiple lobes for the wire length that you choose, you may not want the wire broadside to Europe. Then you must ask where your lower-band broadside signals are going and determine if those are useful directions.

The boldface entries I do not recommend for use. All of them are less than about $3/8\lambda$. As the center-fed wire length grows shorter, the impedance becomes very capacitively reactive, while the resistive component shrinks. With a feedline in the 300-600- Ω range, this combination can result in high losses, even on the parallel lines noted for their low losses. In many cases, your tuner may not be able to achieve a match to 50 Ω —or the setting may result in further losses. For efficient transfer of power from the rig through the tuner and along the line to the antenna, a center-fed antenna wire length should be at least $3/8\lambda$.

The chart and the gallery apply to center-fed doublets. If your feedpoint is at the wire end (the end-fed Zepp) or between the center and the end (the off-center fed wire), only the patterns for a half-wavelength wire are accurate for all three variants. At 1λ , an end-fed wire has a pattern similar to the 2λ center-fed wire, with 4 lobes. However, the intermediate steps differ from those of the center-fed doublet. The patterns for the off-center fed wire tend to depend on the exact placement of the feedpoint. **Fig. 8**

compares 3- λ wires with different feedpoints. The off-center fed version uses a position 1/3 the way in from the wire end and its pattern will vary as you move the exact feedpoint position.

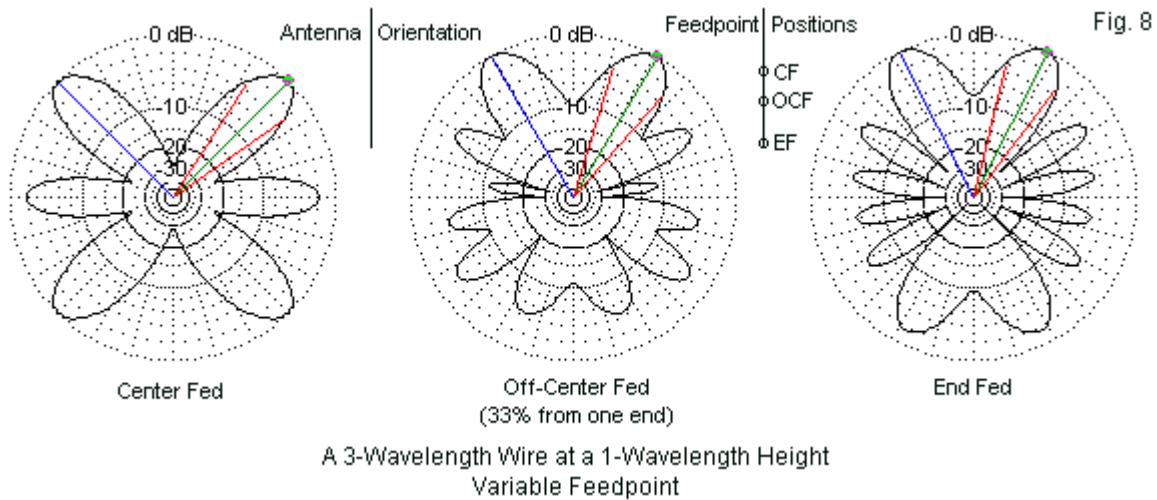

When planning a horizontal wire installation, it pays to obtain at least basic antenna modeling software to go through the exercise in this set of illustrations. Even if you have no choice about the length and the orientation of your horizontal wire antenna, the modeling session will provide you with reasonable expectations on what you will obtain from your antenna considering its height, length, orientation, and feedpoint position. The software will provide azimuth bearings (and beamwidth limiting bearings) that you can apply to a great circle map with your station at the center. The data lets you determine where your signals are going, while the elevation angles let you estimate your chances of getting there.

Vertical Antennas

With basic 1-element vertical antennas, we normally do not give much attention to the azimuth pattern. It is circular, as shown in **Fig. 9**. Our concern is to mount the vertical as free and clear of other objects, especially vertical ones, as our yards may permit. Since we normally cannot measure the self-resonant frequencies of these objects, our best line of defense is to avoid them to the degree that our yards permit. Houses contain all sorts of metal, including vertical runs of wires. Even trees are semi-conductors capable of absorbing RF energy. Since most non-rural locations do not permit a clear area with a 1- λ radius, the rule of thumb is to be as free and clear as the surroundings permit.

The Azimuth Pattern
of Any Single-Element
Vertical Antenna in a
Clear Field

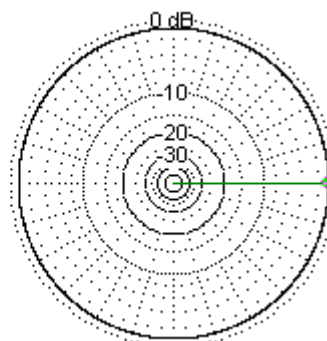
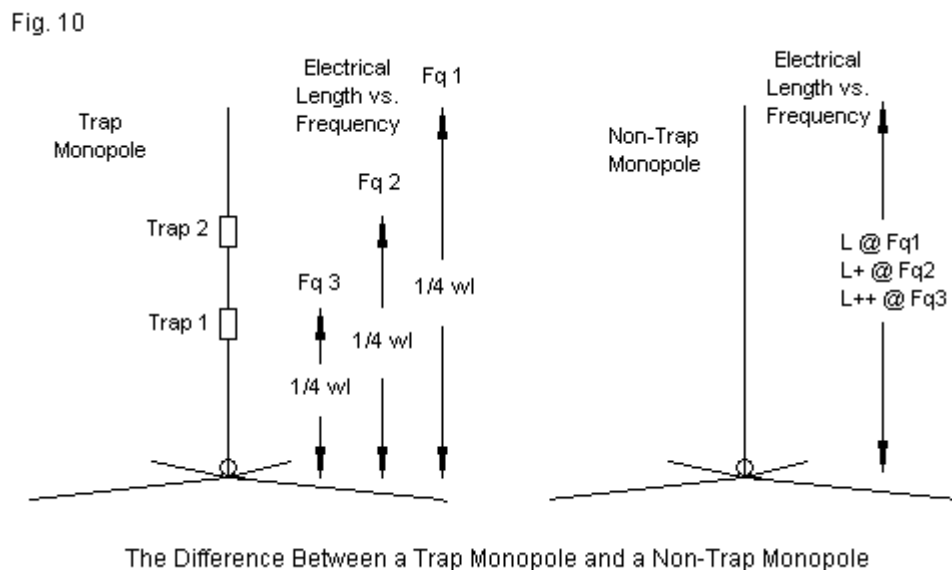

Fig. 9

The performance of a basic vertical antenna will show itself almost completely in elevation patterns. We shall look at several dimensions of the vertical as we think of it as a multi-band antenna. We shall examine four main dimensions: the feedpoint position, the length, and the height above ground, and the ground itself. Together, these factors will form our basic performance expectations.

The most fundamental expectation that we should have emerges from comparing the patterns of horizontal wires with vertical wires. A vertical is omni-directional and radiates equally (well or poorly) in all directions—with allowances for the absorption or reflections due to nearby objects. The energy radiated by a vertical is (or can be with careful installation) the same as the energy radiated by the horizontal antenna. Since the horizontal decreases the radiation off the wire ends, it has more energy to radiate in its main lobes. As a consequence we must use some care in orienting a horizontal wire. In any direction, a vertical has less gain, but it requires no aiming—at least not in its simplest form.

Amateurs typically use two types of verticals: commercially made multi-band trap designs and single wires that we use with an antenna tuner if we wish to cover more than one band. **Fig. 10** shows a crucial difference between the two types of antennas: the electrical length. The figure shows vertical monopoles with radials to complete the antenna. Counting upward from the base or the junction between the vertical elements and the radials, a trap monopole is always $\frac{1}{4}\lambda$ at the operating frequency. The single wire of the same total length is $\frac{1}{4}\lambda$ only at the lowest frequency used and increases in length as we raise the operating frequency.



Incidentally, those short base-loaded vertical monopoles that we see in the field or on apartment balconies are all electrically $\frac{1}{4}\lambda$. Unfortunately, the highest current in the antenna occurs at the antenna's feedpoint. A base load inductor does not radiate significantly, so much of the energy supplied to those types of antenna does not show up in the radiation. Moving the coil to the middle of the short vertical element does not help matters significantly, despite a considerable mythology spread by commercial makers.

We shall focus on antennas that we might use at home. If we build our own vertical antenna, it generally will have one of two forms. If we have an adequate support—either below or above the element—we might build a vertical dipole. The feedpoint, as shown on the left in **Fig. 11**, is normally at the center. To minimize common-mode current traveling along the feedline and into the shack, we normally run the feedline (to the degree possible) at 90° to the element, ideally, all of the way to the shack. Conquering common-mode currents on feedlines is an episode all unto itself, so we shall simply note this facet of a total antenna system. Vertical dipoles look like horizontal dipoles set on their end. In fact, that is exactly what they are. However, that change in orientation makes a world of difference to how they perform. For example, the feedpoint impedance of a horizontal dipole tends to fluctuate as you raise the antenna from close to the ground up to 1λ or more. In contrast, the feedpoint impedance of the vertical dipole remains relatively constant until you bring the lower end of base very close to ground. In

general, vertical dipoles do not need a ground radial system, although with very low base heights (less than 0.1λ), a set of radials or a large chicken wire screen might improve local ground quality a bit.

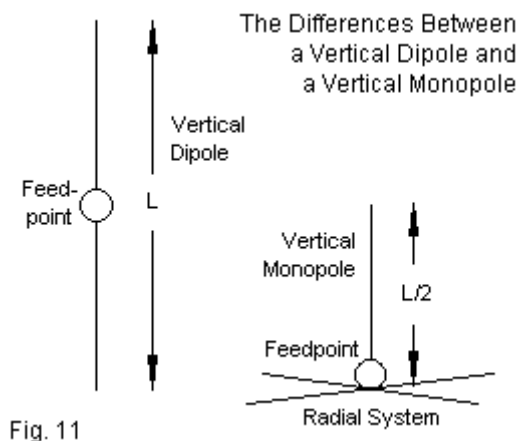

A resonant monopole antenna, shown on the right with 4 radials, is half the length of a vertical dipole and fed at or very close to the base, that is, the junction with the radials. The radials are not a “counterpoise.” That term—highly misused these days—refers to an engineering technique for a screen or ground radial system that was in fact very slightly elevated from the ground and not connected to it. It capacitively coupled to the ground, and a direct connection shorted out the effect. Today, too many people use the terms to try to indicate a relatively non-critical, non-radiating, and even unimportant part of the antenna. From the start, let’s be clear: every part of an antenna radiates and is important. That statement includes the radials that accompany any a monopole.

Monopole radials do radiate. However, we set them up symmetrically so that the radiation of each one is virtually cancelled by the radiation of the others. Radials represent the lower half of a vertical dipole and contribute to the resonant frequency of the antenna. When we bury the radials, interactions with the ground medium plus reflections of energy from the ground make the length of buried radials not critical. When we elevate the entire antenna, the radials become more critical with respect to length and the antenna’s resonant frequency. The feedpoint impedance of an elevated monopole is not half the value of the ($70\text{-}\Omega$) impedance of a resonant vertical dipole—it is closer to $25\ \Omega$. We adjust the length of both the vertical element and the radials to obtain a desired impedance—usually $50\ \Omega$ —in effect, feeding the system off center. The true current peak along the system occurs either higher up on the vertical or somewhere along the radials.

We often wish to use a simple element—without loading or traps—on multiple bands. For any physical length of wire that we select, the wire becomes electrically longer as we raise the operating frequency. You may extrapolate the physical lengths that correspond to various monopole and dipole lengths on the various bands by applying some simple arithmetic to **Table 1** and **Table 2**. Incidentally, while we retain the title of monopole for base-fed system with radials, even when used on bands for which the vertical is not resonant at $\frac{1}{4}\lambda$, the center-fed vertical wire is only a vertical dipole when its length is $\frac{1}{2}\lambda$ or shorter. When we use it at higher frequencies and therefore at longer electrical lengths, it becomes a center-fed vertical doublet.

Suppose that we begin with a vertical monopole that is $\frac{1}{4}\lambda$ at the lowest operating frequency. We then raise the frequency of use so that the antenna becomes longer. Of course, the impedance will change along the way. Therefore, we shall have to apply multi-band techniques for feeding and impedance matching. One very useful application for a remotely tuned and weatherproof remote antenna tuner is with a monopole antenna. For example, if we mount to monopole on a rooftop, we can use a coaxial cable to transfer received and transmitted energy between the antenna and the shack equipment without concern for keeping the line free and clear of potentially disruptive influences. Although parallel feedline to an indoor tuner is cheaper, it requires careful attention to routing.

Fig. 12

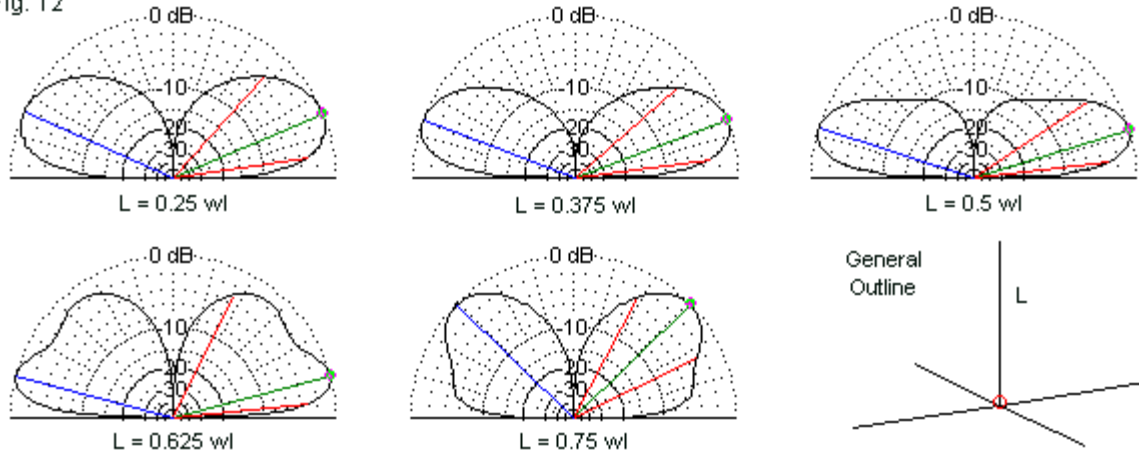

Elevation Patterns of a Monopole of Various Lengths
(Measured in Wavelengths)

Fig. 12 shows what happens as we raise the operating frequency and thereby increase the electrical length of the monopole. The pattern undergoes an evolution that slightly lowers the angle of the strongest radiation as we increase the length. Above a length of 0.5λ , we develop a strong higher-angle elevation lobe. The $5/8\text{-}\lambda$ version represents a practical limit for the monopole. As shown in the pattern for a length of 0.75λ , the radiation angles upwards, which is normally not very useful for amateur operation. Therefore, a monopole with radials generally has a 2.5:1 useful frequency range of use. If we cut the monopole to be $1/4\text{-}\lambda$ at 40 meters, it might not be useful beyond 20 meters, although we might have some limited success on 17 meters. Remember that this restriction does not apply to trap monopoles because these antennas are $1/4 \lambda$ at each operating frequency.

Fig. 13

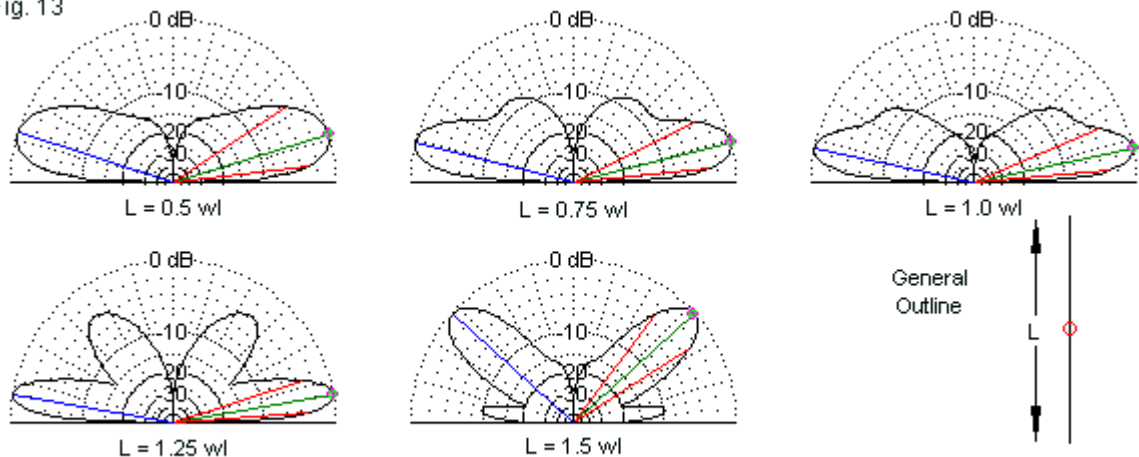

Elevation Patterns of a Vertical Dipole of Various Lengths
(Measured in Wavelengths)

Fig. 13 shows the comparable set of patterns for a vertical dipole with its end very close to ground level. Like the horizontal center-fed doublet, the pattern remains clean, but with a narrower beamwidth as we increase the frequency and the length to about 1λ . The horizontal doublet begins to form side lobes as its length approached 1.25λ . Similarly, the vertical doublet forms secondary elevation lobes at the same electrical length. If you refer to **Fig. 7**, you will see that at a length of 1.5λ , the horizontal doublet's azimuth pattern shows a weak broadside lobe and very strong angular lobes. If you mentally turn the pattern 90° so that half is below ground, you will obtain essentially the same pattern shown in **Fig. 13** as

the antenna's elevation pattern. Most of the energy radiates at a severe angle rather than broadside to the vertical element. The end result is that a vertical doublet also has a limit to its frequency range. When it is electrically longer than 1.25λ , its elevation pattern becomes generally useless for most common amateur applications. A low elevation angle on 10 meters requires a vertical doublet 44' long or shorter. However, the shorter the doublet, the higher will be the minimum frequency for an acceptable matching situation.

One advantage of the vertical doublet is that we may use it effectively at frequencies lower than $\frac{1}{2}\lambda$ resonance. The same lower limit applies to both vertical and horizontal doublets: about 0.375λ . Below that length, the shrinking feedpoint resistance is accompanied by a rapidly growing capacitive reactance. The combination can result in higher line losses and difficult impedance at the antenna tuner terminals. For vertical doublets in multi-band service, parallel feedlines and an indoor tuner generally rule the day, especially if the shack is on the second story of a house.

Although vertical dipoles and doublets are always above ground, monopoles may have either ground level or elevated mounts. Ground mounting is subject to the greatest number of variables that affect performance. Therefore, let's focus on monopoles mounted at ground level with buried radials. (Radials lying on the ground count as buried, although in safety terms they represent a threat to lawn mowers, pets, and family members.)

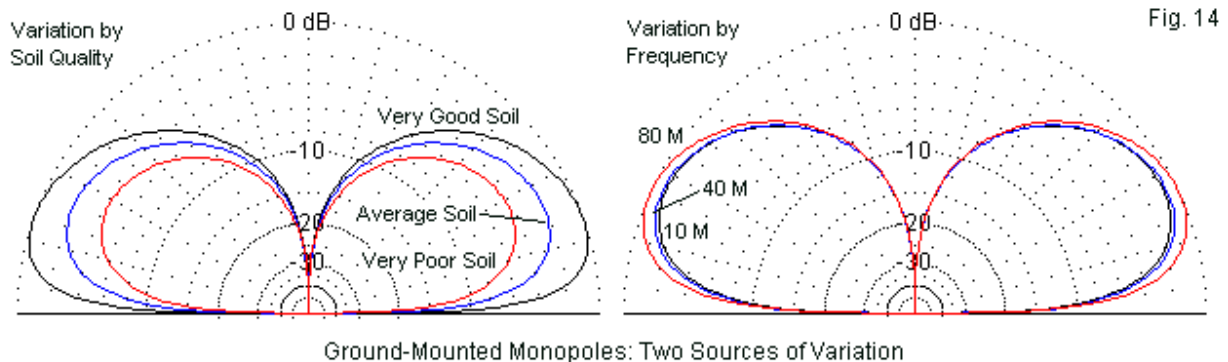
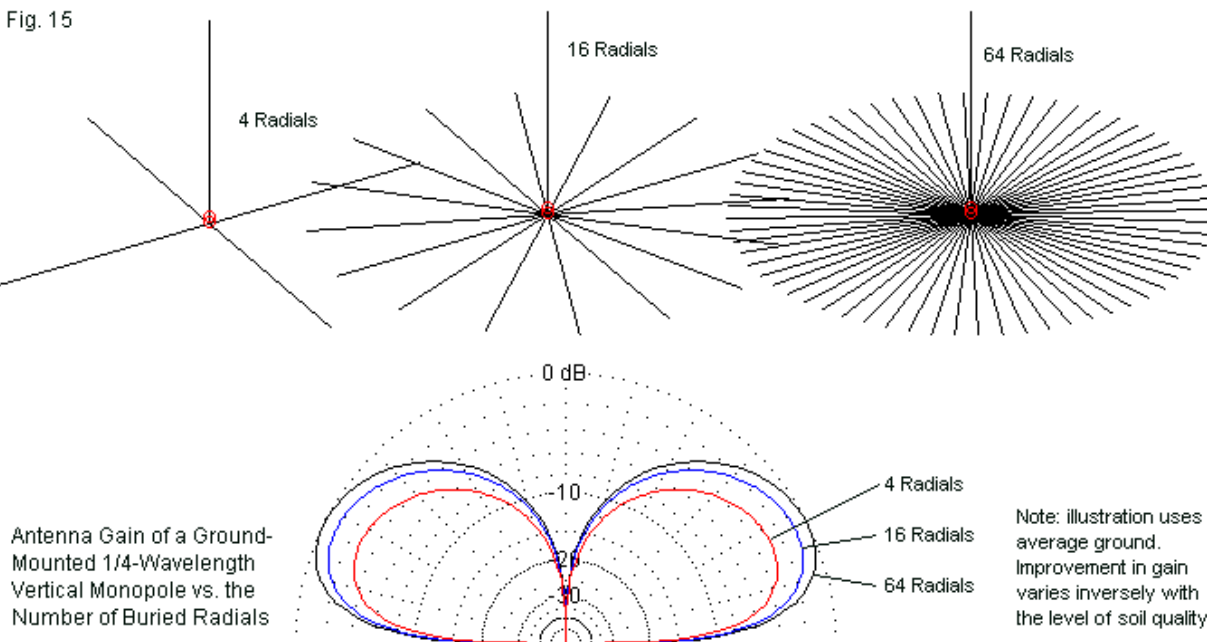

Fig. 14 shows two of the variables that affect the performance of ground-mounted vertical monopole variables. On the left, the three overlaid elevation patterns compare the relative gain of identical monopoles, including very good systems of buried radials. As the soil quality decreases from a very good level through average down to very poor soil, the gain diminishes significantly. Understanding the differences requires that we sort out two basic considerations of ground beneath a vertical monopole. First, we may consider the local ground in which we have buried the radials. Improving this ground with the radial system improves antenna radiation efficiency by reducing the immediate ground losses—the losses that would usually show up in the feedpoint impedance as a higher resistance. The measured feedpoint resistance will be the sum of the antenna's radiation resistance and losses to ground at the antenna (neglecting any antenna material and connection losses, which normally are very small). Since the patterns depend on identical antenna systems, the pattern differences depend less on differences in the local soil than in differences in the ground quality at a greater distance from the antenna. This more distant ground is the region of primary reflection of waves that combine with the direct or incident waves from the element to form the final pattern. It is ground over which we have no control (unless we live on a very large ranch or farm). Therefore, it limits the performance that we can obtain from a ground-mounted vertical monopole. One of the best places for such an antenna is by the seashore.

The effects of ground are not constant as we change frequency. Losses generally rise as we increase the frequency of operation, as suggested on the right in **Fig. 14**. However, the rate of loss increase is greater for lower-band frequency shifts (say, from 160 to 80 meters) than for upper band shifts (say, from 40 to 10 meters). Although the amount of change is not as great as the changes we discover

as the overall soil quality changes, it represents one more variable that makes ground-mounted vertical monopoles a topic of antenna research.

We showed the effects of refraction-zone soil quality differences on signal strength while using a constant radial field. Let's now reverse that procedure and look at changes that we can make in the local ground using a constant overall ground quality. The ground will be average, but our radial systems will be very different. **Fig. 15** shows 3 monopoles with buried radials. The field sizes increase by a factor of 4 in each step, going from 4 to 16 to 64 radials. The fields represent relatively standard amateur practice, with a 4-radial system being a common minimum. Hard workers tend to use 16 radials, while somewhat rabid vertical users go as high as 64. Commercial stations tend to use 120 radials.



The lower part of the figure overlays 3 elevation patterns. Note that we obtain the largest increment of improvement when moving from 4 to 16 radials. However, the improvement as we move from 16 to 64 radials is not so small that we should ignore it. In fact, we might stop at 16 radials if the overall soil quality is very good or better. However, that condition is fairly rare. It is more likely that our soil is worse than average—especially in modern urban and suburban settings. Under those conditions, the increments of improvement would be even larger. It is almost true that you cannot have too many radials with a ground-mounted vertical monopole. If you can bury a metal disk with a radius of about $\frac{1}{4} \lambda$, so much the better. Indeed, the length of the radials from about $\frac{1}{4} \lambda$ up to about $\frac{1}{2} \lambda$ is not critical in buried systems

The length of radials for an elevated vertical monopole becomes much more significant in terms of trimming the antenna to an acceptable feedpoint impedance. However, we do not need nearly so many radials. With a base height (that is, the junction of the vertical element and the radials) of perhaps 0.1λ , we need only 4 to 6 radials, and additional radials will not improve performance further.

There is an old saying that you cannot place an antenna too high. That saying normally applies to horizontal antennas. Within the practical limitations of the antenna sizes that we encounter in the HF range, the base height of a vertical monopole and its radials can make a considerable difference in performance. As we elevate the base of the monopole, we slowly reduce the elevation angle of maximum radiation and equally slowly raise the antenna gain. On the assumption that we cannot place the antenna base at least 1.5 to 2λ above ground, raising the antenna height does have a limit. **Fig. 15** traces the evolution of the elevation patterns of a monopole over average ground as we slowly raise its base level from very near the ground to about 0.5λ .

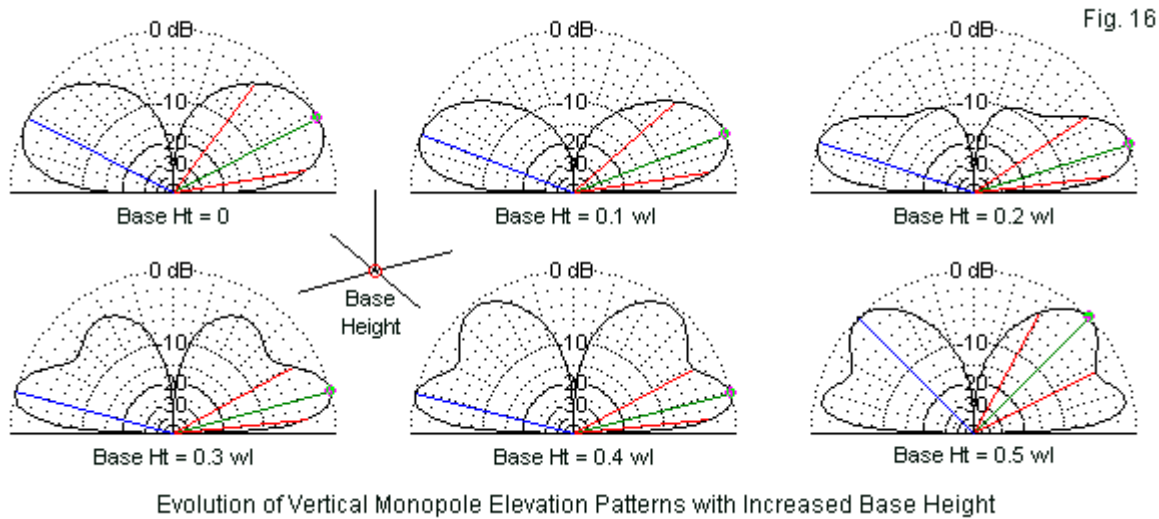

The evolutionary steps show a clean pattern (with little sensitivity to high-angle QRM and QRN sources) with a base height of 0.1λ . As we further increase the height above ground, a secondary elevation lobe emerges and grows with every increment of height. Eventually, by a height of 0.5λ above average soil, the higher-angle lobe comes to dominate over the weaker lower lobe. The antenna is still usable, because the lower lobe has more gain than the main lobe of the version with a base height of 0.1λ . But the high lobe will allow us to hear nearer source of noise that may reduce the signal-to-noise ratio of lower-angle distant signals.

Now suppose that we place a multi-band vertical monopole (either simple or trapped) on a rooftop that is 20' above ground. At 10 meters, the antenna height is already well above $1/2 \lambda$. In fact, 12 meters has a 20' half-wavelength. At 40 meters, the height is down to about 0.15λ . Although the pattern is cleaner, the gain is less. Before we despair over this compromise, consider band conditions. For our sample antenna, the pattern is cleaner on the bands where we most expect to encounter high-angle QRN and has it large higher-angle lobe in the generally quieter frequency region. So the compromise 20' (or thereabouts) mounting height is perhaps no so bad after all.

Vertical dipoles and doublets are subject to the same sort of pattern evolution, as suggested by the gallery of elevation patterns in **Fig. 17**. The patterns differ in detail because the feedpoint of a vertical doublet or dipole is always higher than it is for a vertical monopole.

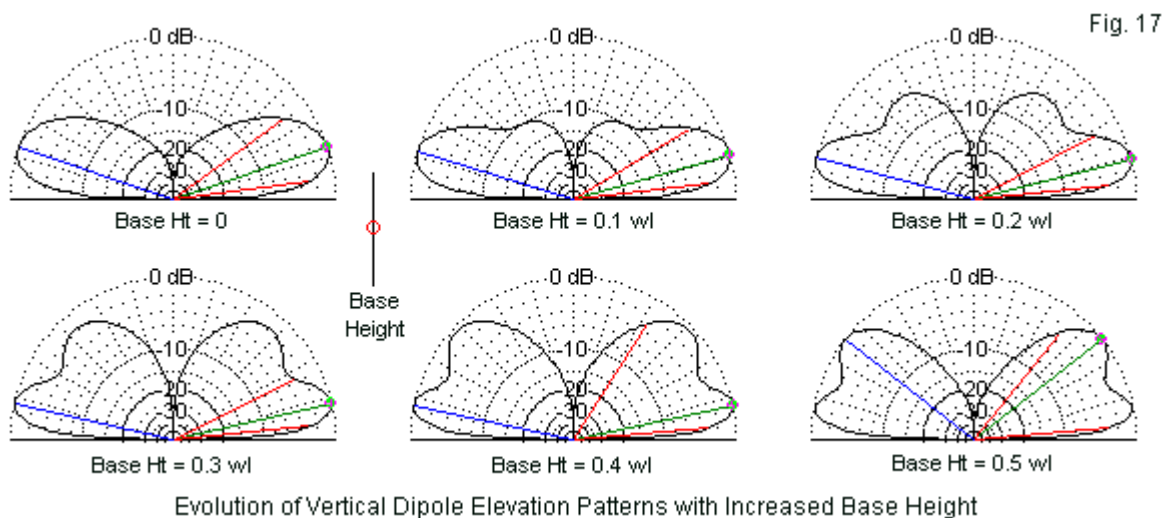

The patterns use the doublet's lower free-end as the base height. The feedpoint is always $\frac{1}{2}$ the distance from the lower wire end to the upper wire end. If you should wish to work 30 to 10 meters with a 44' wire, but with a little higher gain and if you have a convenient support, you might raise the antenna to a base height of about 15' to get the most performance out of it on all of the bands.

Because horizontal antennas show azimuth patterns with at least two lobes and at least two nulls, their maximum gain at the center of the lobes is greater at the elevation angle of maximum gain than the gain of an omni-directional vertical antenna. For many operators, especially those who hate digging the earth to lay down radials, the simplicity of the horizontal wire gives them a decisive advantage. However, the vertical antenna has its champions as well, especially among those with very limited real estate and those who wish to have omni-directional coverage. In addition, there are a number of hams who cannot install horizontal antennas at a high level on the lower HF band who therefore favor vertical antennas.

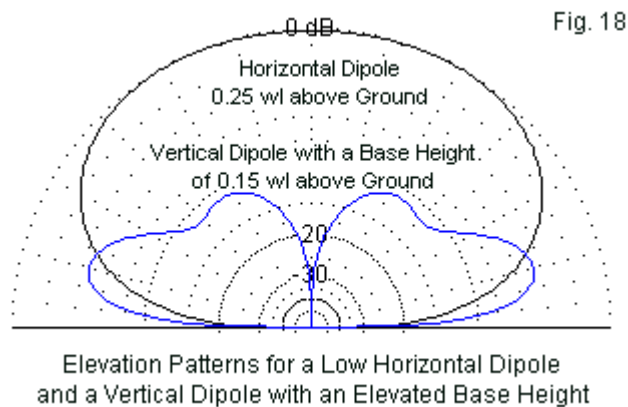

Suppose that you can only install your horizontal dipole at $\frac{1}{4} \lambda$ above ground. That height would be about 35' on 40 meters. In the favored directions, your elevation pattern would resemble the large oval in **Fig. 18**. In contrast, a vertical dipole with its base about 0.15λ above ground would provide the smaller pattern. A monopole with the same base height would produce a similar pattern. The vertical's pattern has two advantages in the eyes of some operators. First, it is relatively insensitive to signals and noise at high angles. Second, most very long-distance signals come and go at quite low angles, from a few degrees to perhaps 15° elevation. In this elevation range, the vertical actually has more gain. Of course, raising the horizontal wire to a height of $\frac{1}{2} \lambda$ would put the horizontal dipole in the more advantageous position, but only broadside to the wire. Off the ends, the vertical's omni-directional pattern would again be superior.

In the seeming war between vertical and horizontal basic antennas, there is no winner in the abstract. The only winner is an antenna that will fit your property and your operating needs and desires—within a budget that allows your family to have shoes and to eat regularly. Understanding the basic radiating properties of both types of antennas is important to making the right decision.

Bent Antennas

Our final category of basic antennas involves bending the antenna wire in certain proven ways, in order to fit an antenna into our property lines, to reduce the number of required supports, or to achieve a certain type of performance. Space prevents us from doing a thorough survey, since there are in principle an endless number of ways to bend antennas. Even if we restrict ourselves to a single bend per antenna, we still cannot cover everything. Therefore, we shall briefly look at a number of single-bend antennas, the ones that appear in **Fig. 19**. Three out of the four antennas in our catalog make their bend in the vertical plane and only one in the horizontal plane (the quadrant). As well, three out of the four antennas typically use a center feedpoint, with only the inverted-L normally using an end feedpoint. Our task will be to see for what each type is useful and how each may differ in performance from any straight-wire counterparts.

Fig. 19

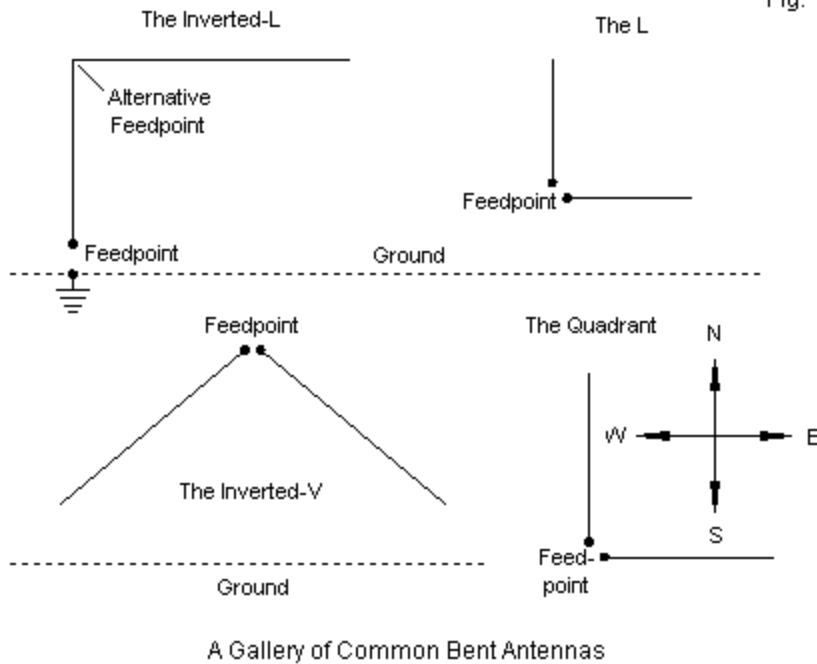

All of the antennas in **Fig. 19** are essentially the same antenna. If you bend a half-wavelength wire in the middle and keep the feedpoint there, then the resonant impedance—after pruning—drops from the typical dipole value of 70Ω down to the $50\text{-}\Omega$ vicinity. The only difference among the antennas in the sketch is the orientation of the wire around the bend. However, that difference makes a big difference in application.

The name “quadrant” antenna is less well known in the US than in Europe, where the average home yard or garden is smaller. By necessity, amateurs simply bent a straight horizontal dipole around a corner and gave it a mysterious name. However, the antenna remains a horizontal antenna and follows the same rules as its linear counterpart. For example, the elevation angle of maximum radiation depends on the height of the antenna above ground. At a height of a half-wavelength, the angle is about $27\text{-}28^\circ$, while at a height of 1λ , the angle drops to about $14\text{-}15^\circ$.

The quadrant form of a doublet does show considerable changes in the azimuth patterns compared to a linear dipole. A linear dipole has minimal radiation off the ends of the wires. In the bent configuration, the ends no longer form a straight line with the center or high-current region of the antenna. Hence, we obtain more radiation off the virtual line we might draw between element tips. The result is shallower or non-existent nulls at right angles to a line drawn through the feedpoint and directly between the two tips—the virtual broadside direction. The first pattern of **Fig. 20** shows a typical quadrant dipole pattern with an antenna height of 0.5λ . Compare this pattern to the dipole pattern in **Fig. 7**.

As we make the antenna longer in wavelengths—usually by raising the operating frequency—we notice more radical changes in the azimuth pattern—so much change that we cannot use **Fig. 7** as a guide for aiming the quadrant. The remaining patterns in **Fig. 20** sample some of the patterns. When the wire is a total of 1λ , the pattern yields almost a square rather than giving us the linear doublet narrow-beam bi-directional azimuth plot. At a total length of 1.5λ , we do not obtain a 6-lobe pattern, but instead, a bi-directional pattern with end “bulges.” When we reach a total length of 2λ , we return to a 4-lobe pattern that seems to replicate the pattern in **Fig. 7**. However, each lobe is much narrower than the lobes of a linear doublet having the same total length. In addition, two of the lobes are directly broadside to the virtual plane of the antenna, while the other two are at 90° to the bi-directional broadside line. As a multi-band doublet, the quadrant requires considerable independent study before committing to its use.

Quadrant Antenna Azimuth Patterns at Various Lengths Relative to the Operating Frequency

Fig. 20

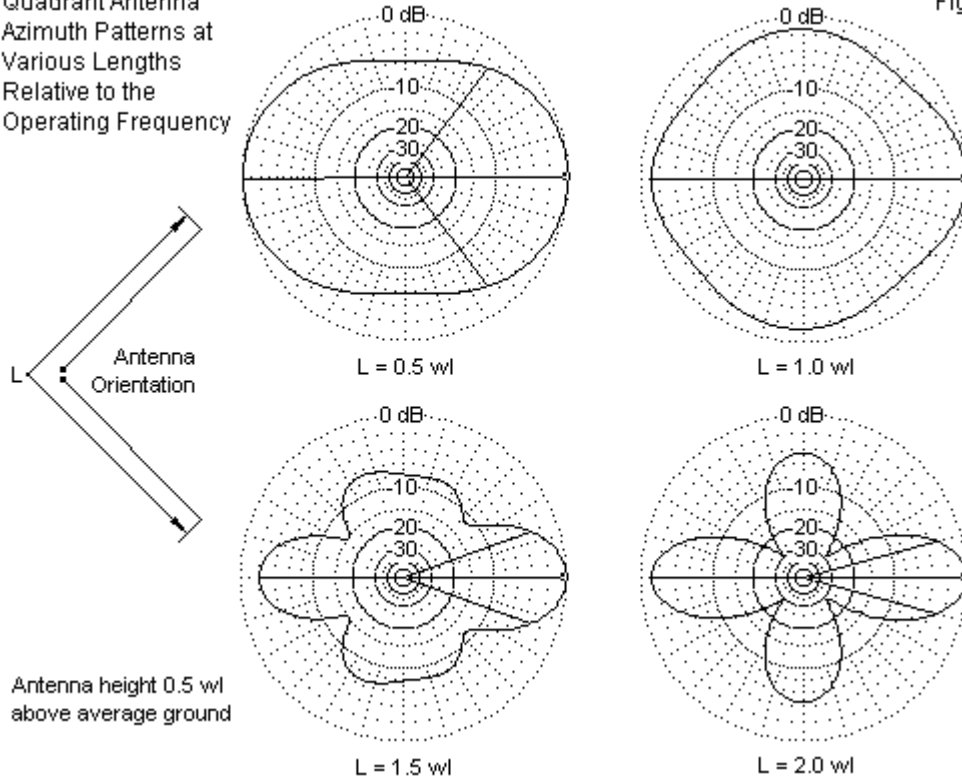

Although the quadrant multi-band doublet is not a true (unterminated) V-beam, the right-angle bend places it near the edge of that category, especially as the total length grows to 3 or 4 λ . At longer lengths for each side of the center feedpoint, the antenna provides more consistent bi-directional performance than a straight doublet. Hence, the antenna may have more appeal than simply as a way to fit a horizontal antenna into limited yard space.

The (upright) L antenna normally finds applications at 10 meters and higher, where we may more easily develop an elevated mounting. Developed in the 1950s as an antenna for boats, the upright L has amateur use because it exhibits a mixture of vertical and horizontal components, as suggested in **Fig. 21**. The mixture results in elliptical polarization, which is handy for local communications with some stations using horizontal antennas and some using vertical antennas. Since the L, especially when constructed from fat tubing, is broad banded, we can cover all of 6 or 2 meters locally with one antenna.

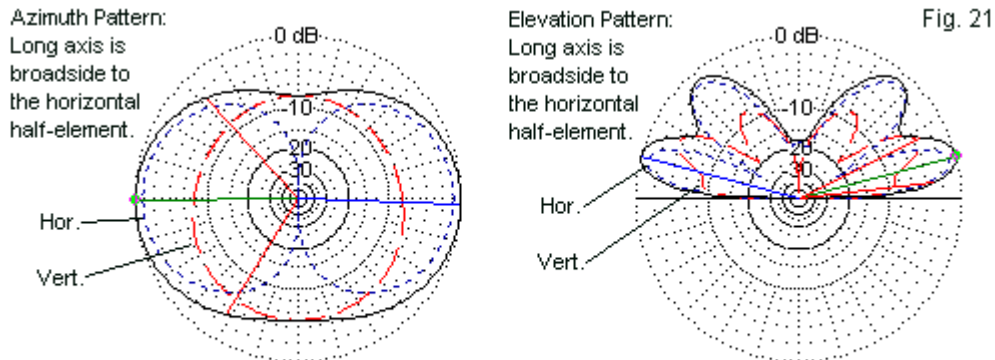

L-Antenna at 1 Wavelength above Average Ground
Azimuth and Elevation Patterns with Vertical and Horizontal Components

Because horizontal half-element of the upright L is at the bottom, we do not find many HF band uses, especially below 10 meters. Instead, we find an antenna almost as old a radio itself. The “inverted-L” label goes back at least to 1920 and perhaps before. It consists of a single wire with part vertical and part horizontal. The most usual feedpoint is at or near the ground at the base of the vertical section. However, some amateurs have fed the antenna at its center with good success, using parallel feedline. To keep the feedline at nearly right angles to the antenna, the line runs as close to parallel with the ground for as far as possible, in the same way we might handle a vertical dipole or doublet. This system is especially convenient for second-story shack locations.

Two years ago, I provided FDIM 10 with a special report on this antenna, covering as many variations as space would permit. You may find a copy of “Straightening Out the Inverted-L” in the FDIM archives or at my web site (<http://www.cebik.com/fdim/fdim10.pdf>). The article even contains some construction hints. Here, we shall provide only one fundamental idea that is common to all base-fed inverted-Ls.

Fig. 22

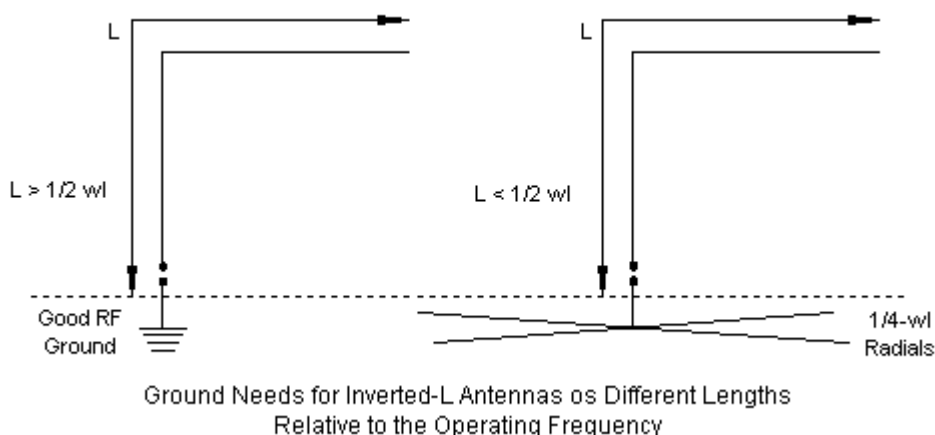

As shown, in **Fig. 22**, the need for a radial system with an inverted-L fed at its base depends on the length of the antenna. If the total length is about $\frac{1}{4} \lambda$, give or take a good bit, then the antenna wire acts like a bent-over vertical monopole. Under these conditions, a set of approximate $\frac{1}{4}\text{-}\lambda$ radials is necessary to complete the antenna in less loss-laden ways than the ground itself will provide. Use the same rules governing the number of radials that we examined while exploring vertical antennas in general.

If the wire is at least $\frac{1}{2} \lambda$ at the lowest operating frequency, we technically do not require radials for effective inverted-L operation. However, note the “good RF ground” label in the sketch. Ordinarily, we would use an antenna tuner, since the impedance is unlikely to match any feedline we might like to use, especially if we use the antenna on multiple bands. It is possible to use a parallel feedline to a shack tuner, but routing the line from ground level to the shack entry and still maintaining good clearance from all disturbing objects—including the ground—is very difficult. Hence, a weatherproof remote tuner with a coaxial cable back to the shack is a good investment. Such tuners need a good RF ground, which might consist of some radials, plus a long ground rod for safety switching in the event of electrical storms. Since the end of the antenna is at ground level, local ground improvement may also reduce ground losses.

Beyond its use as a single tall-support substitute for a resonant dipole, most writers have tended to ignore the inverted-V. The inverted-V is a center-fed antenna with the free wire ends at a lower height than the center. (We do not find many upright-V antennas, since that configuration places the highest current region and hence the maximum radiation region close to ground.) We can specify an inverted-V by reference to angles, but there are two common ways of counting the angles involved. One way—the one used here—registers the angle of slope between the V element halves and a corresponding straight-wire center-fed antenna. We shall focus on only two of the many possible angles for an inverted-V: 30° and 45° .

The other method of designating an inverted-V is to record the angle between the two wires. A linear center-fed wire would be a 180° inverted-V. The two antennas with which we shall work are 120° and 90° inverted-Vs, respectively. In most cases, more severe (acute) angles place the antenna tips on the ground or very close to it. In general, the antenna ends should be as high as is feasible within the specific installation conditions. As the ends of an inverted-V approach the ground more closely, the overall antenna gain goes down and the bi-directional pattern becomes a broad oval at the frequency for which the total length is electrically $\frac{1}{2} \lambda$.

If the wire slope is not too great, the elevation angle of greatest radiation is not significantly higher than the corresponding angle for a linear wire at the same center height. However, changing the angle between wires gradually changes the azimuth patterns that we obtain in multi-band service, when the total wire length is much longer due to the use of higher operating frequencies. **Fig. 23** provides a sample gallery that includes patterns for both the 30° and the 45° Vs. The height of the feedpoint is 1λ at the lowest operating frequency.

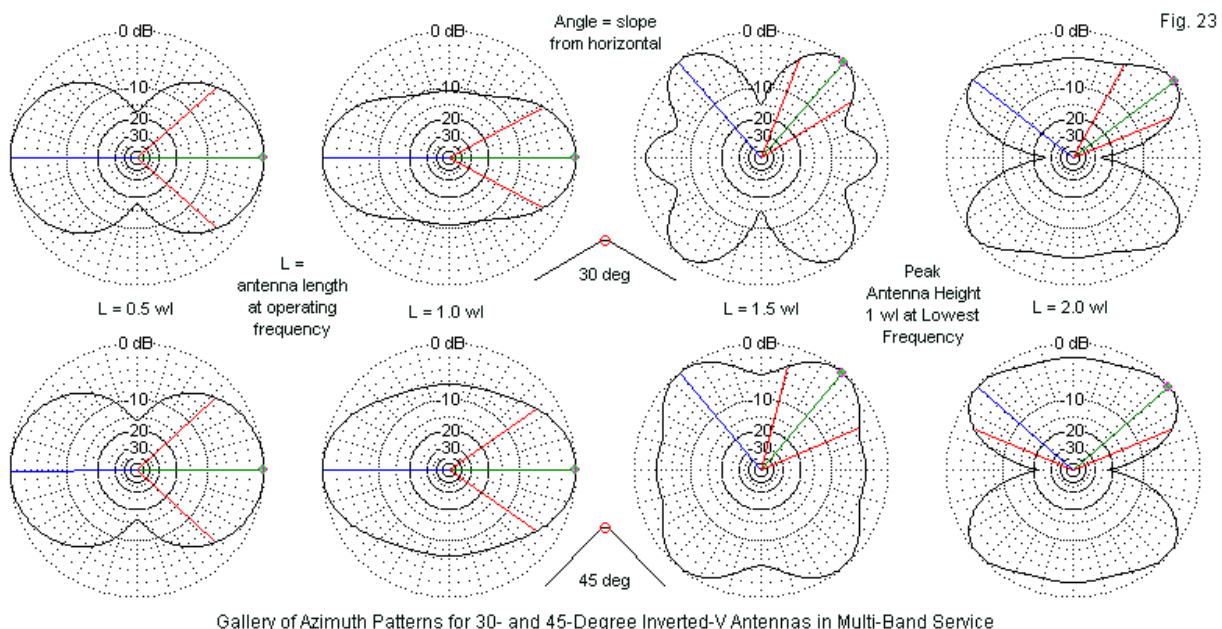

The gallery makes clear that the sloping wires provide significant radiation in the wire end directions. Compare the patterns especially for lengths of 0.5λ and 1.0λ with corresponding patterns in **Fig. 7**. (Although the identifying V sketches show a broadside view of the antenna, the azimuth patterns presume that the wire orientation is up and down on the page.) As we compare the 30° and the 45° patterns, we notice increased end radiation with the steeper angle. The more radiation that we find in the wire-end directions, the weaker will be the radiation broadside to the plane of the inverted-V. (Note that the patterns do not record relative gain strengths, since the separate plots all use the outer plot ring for the strongest gain within the individual patterns. Our chief interest in the plots is the pattern shape.)

As the total wire length grows electrically longer, the azimuth patterns alone do not tell the full story of multi-band use of an inverted-V. We do see that the V structure fills in some of the nulls between lobes that we obtained with a linear doublet. Let's add to this information something that we learned about the quadrant antenna. As we increased the electrical length of the quadrant, its azimuth patterns became more aligned with the virtual line we might use to bisect the wires. Now think of the inverted-V as a quadrant antenna with the feedpoint elevated until it is directly over another virtual line between the antenna tips. We have converted the quadrant into an inverted-V. With a long electrical length, considerable radiation goes directly up and directly down, following what used to be the azimuth line of radiation for the quadrant form. Of course, much of the downward radiation from the long V reflects back

upward. As a result, at certain wire lengths, we may find that an inverted-V provides stronger radiation straight up than it does at any other angle to the antenna.

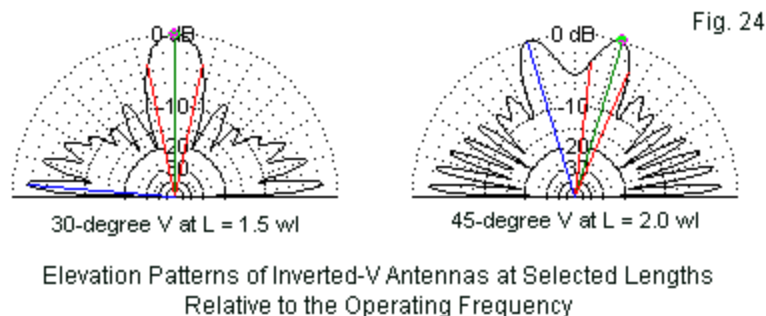

Fig. 24 provides two sample elevation patterns using the 30° V with an electrical length of 1.5λ and the 45° V with an electrical length of 2.0λ . In both cases, we find stronger radiation going upward than we find at the lower angles that tend to enhance most amateur communications. Most folks tend to overlook this significant limitation of the inverted-V configuration.

Conclusion

Since we must inevitably complete the current work somewhere, this point is as good or bad as any other. We might have included any number of other antennas that seem equally basic. For example, we did not mention closed horizontal loops except in passing. The folded dipole found no home here. As well, we did not mention such simple and common antennas as the vertical delta, rectangle, or quad, and the half-square is nowhere to be found. So we have not by any means created even a beginner's complete catalog.

However, our goal has been to linger on the antennas that we did cover at least long enough to develop a set of reasonable expectations about their performance. We discovered that our concerns and our expectations differed according to whether our basic antenna was a horizontal wire or used a vertical element. We also learned that bending an antenna is feasible, but that we had to develop new expectations according to how and where we bent it. Perhaps that is sufficient for one exercise.

Back to Basics

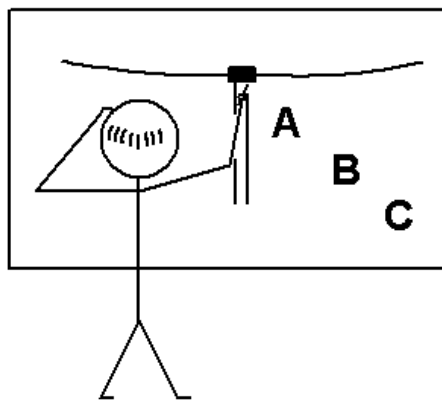

FDIM
2007

L. B. Cebik
W4RNL

URL: <http://www.cebik.com>